

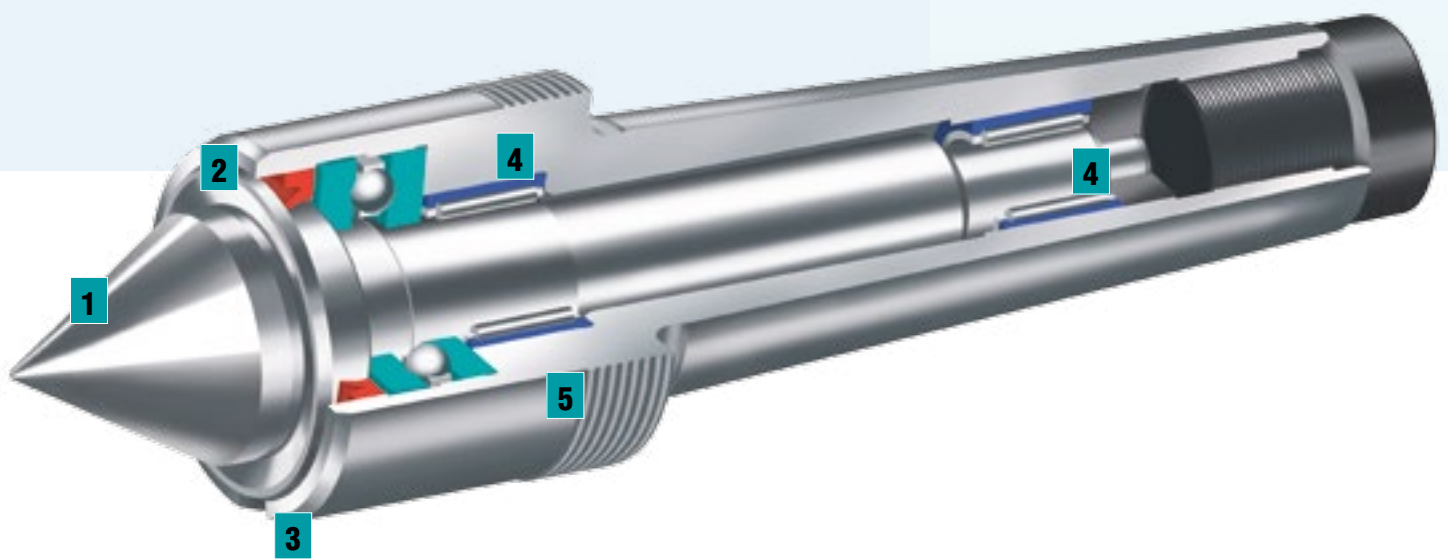

High Performance Live Centres **Types CS/CE**

Short design with small housing diameter

For mechanical manufacturing



Types CS/CE

Compact precision design for mechanical processing

With its short anti-vibration design, the small housing diameter and precision bearings our types CS and CE are ideal for a wide range of mechanical manufacturing operations.

Bearings are reliably protected from the ingress of dirt and coolant by the **deflector** integrated into the centre spindle and the proven **TOP-SEAL-SYSTEM**.

The service friendly design assures minimum repair costs:

Needle bearings with outer ring. In case of needle bearings wear the housing is not damaged and can be re-used with new replacement bearings.

- 1 High concentricity accuracy**
tested under axial load, guaranteed by test report
- 2 Coolant deflector**
a deflector integrated into the through-hardened centre spindle deflects most of the coolant
- 3 TOP-SEAL-SYSTEM**
undeflected residue is wiped off the seal and flows through the drain groove (see page 3)
- 4 Precision bearings**
bearing seats of housing and centre spindle are precision ground and matched to the bearings
- 5 Housing**
of high tensile alloyed tool steel. Housing head and shank are case-hardened for protection against damage

High Performance Live Centre – Type CS

small housing diameter, short design



Type CS

Centre spindle 60°
with coolant deflector
and TOP-SEAL-SYSTEM

Runout

max. 0.003 mm
also available with 0.001 mm
with test report

Application

use where the workspace is constrained
or limited for turning, high performance
turning, hard turning, fine turning,
cylindrical grinding

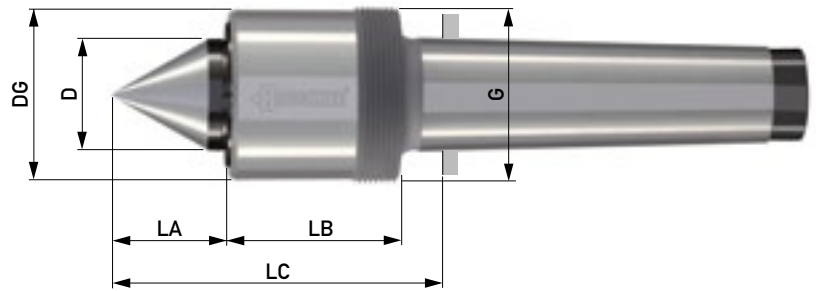

Coolant deflector + TOP-SEAL-SYSTEM

Coolant strikes the circular deflecting surface
and its largest part is deflected away from the
centre housing. The residue is wiped from the
seal and flows through the drain groove.

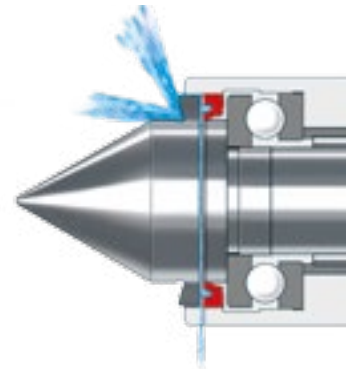

Type CS	ID.No.	600S 032002A	600S 035003A	600S 046004A
Morse taper		2	3	4
D		18	22	30
DG		32	35	46
LA		19.5	23	30
LB		35.5	43.5	46
LC		60	71	81.5
G		M35x1.5	M38x1.5	M48x1.5
Workpiece weight max. daN*		150	325	460
r.p.m. max.*		5500	5000	5000
Radial/axial load graph		RY1/AY1	RY2/AY2	RY3/AY3
Draw-off nut (page 4)		M35DIN1804	M38DIN1804	M48DIN1804

*observe the load graphs

Radial and axial loads for a bearing life of 2000 operating hours

Radial – Type CS

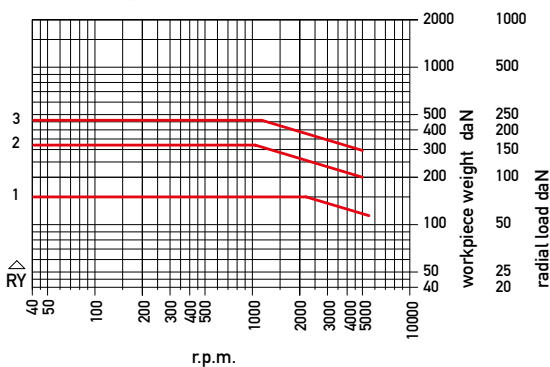

Axial – Type CS

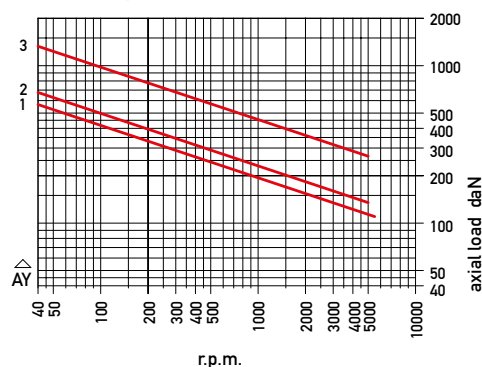

High Performance Live Centre – Type CE



small housing diameter, short design

Type CE

Centre spindle with internal taper 1:7.5 for interchangeable inserts with coolant deflector and TOP-SEAL-SYSTEM

Runout

max. 0.003 mm inside the internal taper also available with 0.001 mm with test report

Runout of the system can be minimized by twisting the insert in the internal taper

Application

use where the workspace is constrained or limited for turning, high performance turning, hard turning, fine turning, cylindrical grinding

Multiple options through a choice of 8 interchangeable inserts

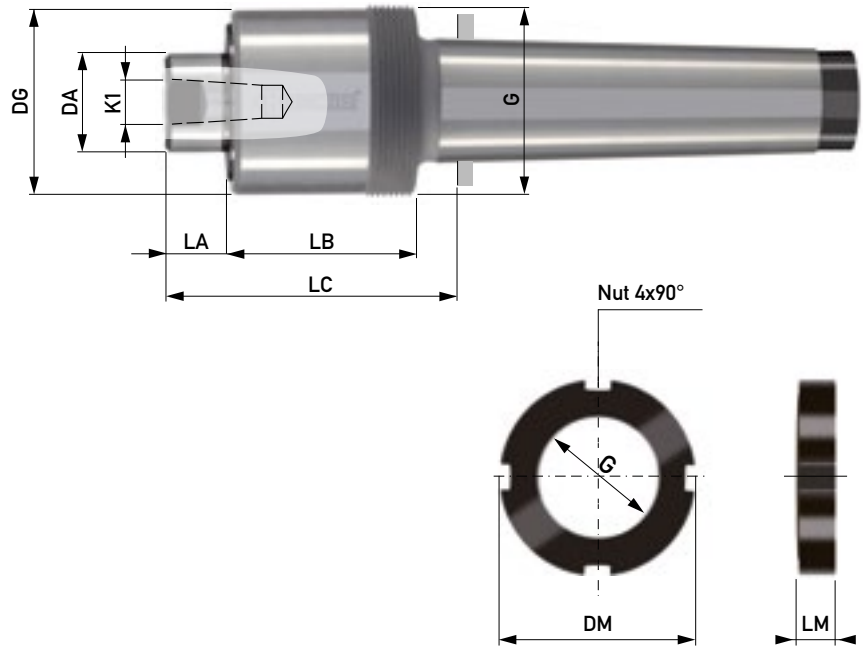

Draw-off nut			
ID.No.	G	LM	DM
M35DIN1804	M35x1.5	11	55
M38DIN1804	M38x1.5	11	58
M48DIN1804	M48x1.5	13	75

Type CE	ID.No.	600E 032002A	600E 035003A	600E 046004A
Morse taper		2	3	4
DA		20	22	25
DG		32	35	46
K1		11	11	15
LA		12	13	15
LB		35.5	43.5	46
LC		52.5	61	67
G		M35x1.5	M38x1.5	M48x1.5
SW		16	16	22
r.p.m. max.		5500	5000	5000
Load		The radial load of type CE is restricted by the interchangeable inserts (page 5)		
Draw-off nut		M35DIN1804	M38DIN1804	M48DIN1804
Suitable inserts (page 5)		482	482	484

Interchangeable inserts

taper 1:7.5, in gauge accuracy

Form A0, 60°
with draw-off nut

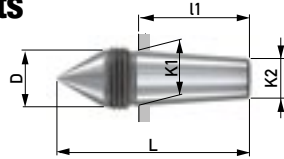

Form ASL, 60°
slim, extended
with draw-off nut

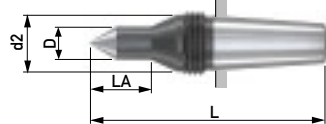

Form AKOP, 60°/40°
extended
with draw-off nut

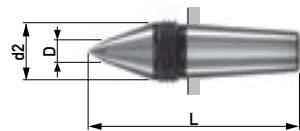

Form A, 60°
for hollow parts
spanner flat (SW)

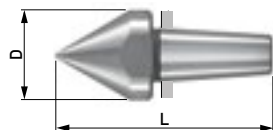

Form B, centre 60°
for centreless workpieces,
with draw-off nut

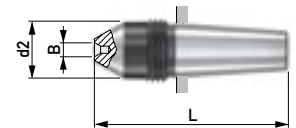

Form C, centre 60°
for centreless workpieces,
external angle 60° for hollow
parts, spanner flat (SW)

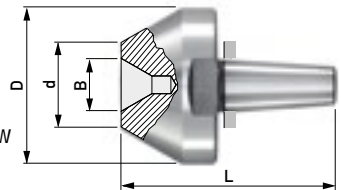

Form D, centre 60°
for centreless workpieces,
spanner flat (SW)

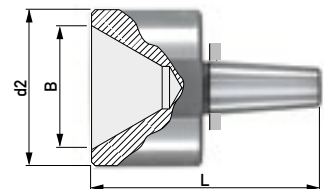

Form AOHM, 60°
with carbide insert
with draw-off nut

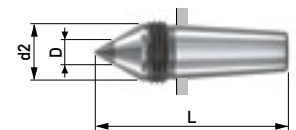

Basic centre Type:CE	Interchangeable inserts	Radial load max. daN	Insert dimensions						Thread SW	Taper dimensions taper 1:7.5		
			D	d2	B	d	L	LA		K1	K2	I1
600E 032002A 600E 035003A	482AO	90	11.7				45		M14x1.5	11	8	23
	482ASL	30	6	11.7			55	15	M14x1.5			
	482AKOP	90	5	11.7			50		M14x1.5			
	482A	90	17				45		SW14			
	482B	90		11.7	4x2		45		M14x1.5			
	482C	90	28		8x3	12	45		SW24			
	482D	90		28	20x6		45		SW24			
	482AOHM	60	7	11.7			45		M14x1.5			
600E 046004A	484AO	160	15.7				53		M18x1.5	15	11	30
	484ASL	100	9	15.7			65	17	M18x1.5			
	484AKOP	160	6	15.7			58		M18x1.5			
	484A	160	25				60		SW22			
	484B	110		15.7	4x2		53		M18x1.5			
	484C	160	44		15x5	24	60		SW41			
	484D	160		44	35x12		64		SW41			
	484AOHM	60	7	15.7			53		M18x1.5			

ID.No.	Content
P 10	100 g

Installation paste

Makes insert change easier.
Apply thinly and evenly to the insert taper.

Changing of inserts

Depending on the style the insert can be removed by its draw-off thread and draw-off nut or with spanners applied to the spanner flats.



Karl Bruckner GmbH
Präzisionswerkzeugfabrik

Bruckwiesenstrasse 11-13
71384 WEINSTADT
GERMANY

Phone +49 (0) 7151 9671-0
Fax +49 (0) 7151 9671-23
info@karlbruckner.de
www.karlbruckner.de



High performance Live Centres and Face Drivers