

11/18/13	XXX	REV_DESC	LJH	WHR	JML
REV	DATE	DES	REVISION DESCRIPTION		CADD

12"x8"x16" Regular Weight CMU Solid Bottom Bond Beam (U-Block)

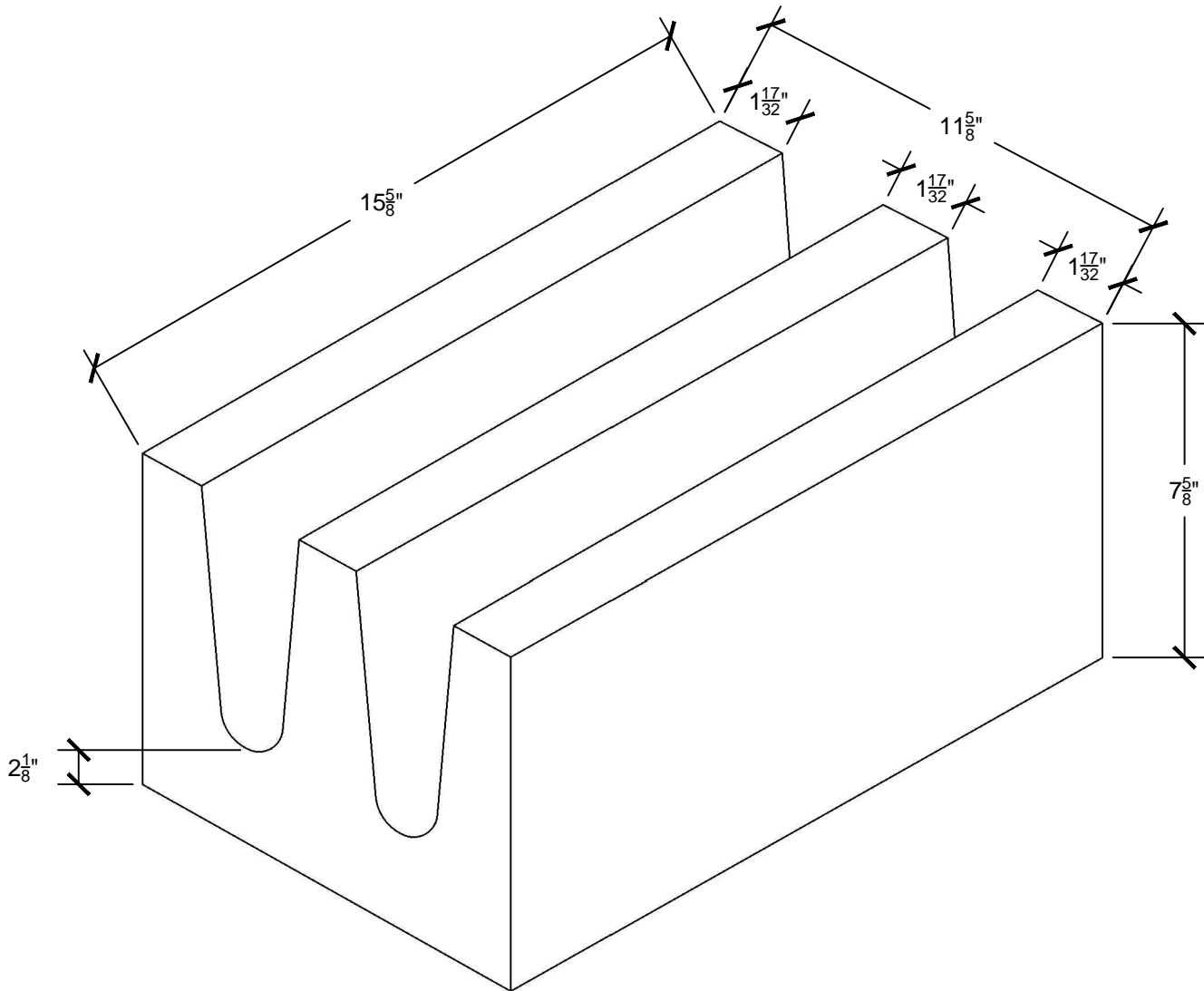

MEETS:

- ASTM C-90



PROJECT			
TITLE 12x8x16 Regular Weight CMU Solid Bottom Bond Beam (U-Block)			
DESIGN	BGR	12/13/13	FILE No.
CADD	LJH	12/13/13	SCALE 3"=1'-0"
REVIEW	MF	02/01/16	REV. 0
PROJECT No.			
DRAWING: CMU-12x8x16 BB U			