

△	11/18/13	XXX	REV_DESC	LJH	WHR	JML
REV	DATE	DES	REVISION DESCRIPTION	CADD	CHK	RW

**12" SUMP (NON STATE)**

18" OUTSIDE DIMENSION  
WEIGHT: 3450 lbs.

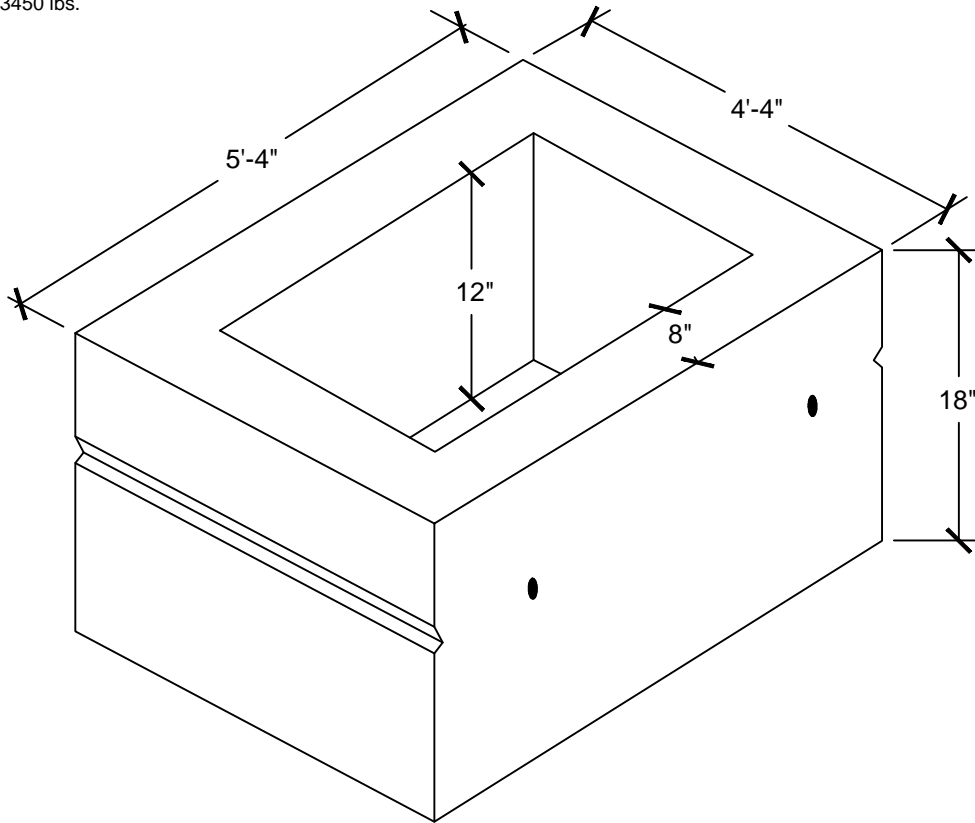

ISOMETRIC

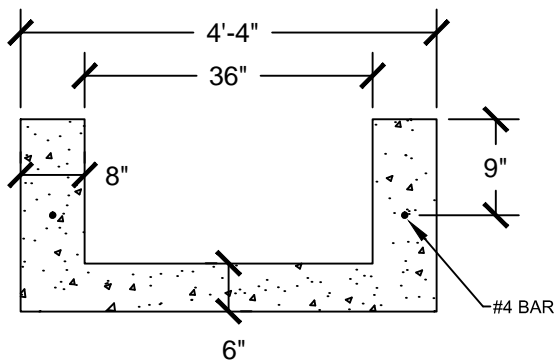

SHORT SIDE

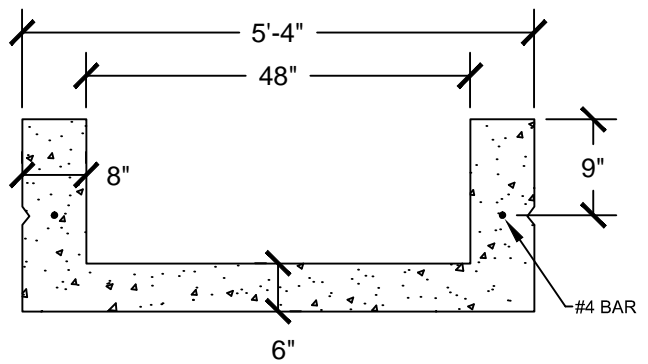

LONG SIDE

**CLASS "FSC" SELF-CONSOLIDATING CONCRETE  
4,000 PSI**



PROJECT	CLIENT NAME PROJECT INFO				
TITLE	12" SUMP				
DESIGN	BGR	02/12/14	FILE No.		
CADD	LJH	02/12/14	SCALE	AS SHOWN	
REVIEW	MF	12/21/15	REV.	0	
PROJECT No.					

**DRAWING: 12" SUMP**