

01/06/16	XXX	REV_DESC	MF	WHR	MW
REV	DATE	DES	CADD	CHK	RVW
REVISION DESCRIPTION					

RISER

WITH 2 KNOCK OUT LONG

1 KNOCK OUT SHORT

(24", 30", 36" & 42")

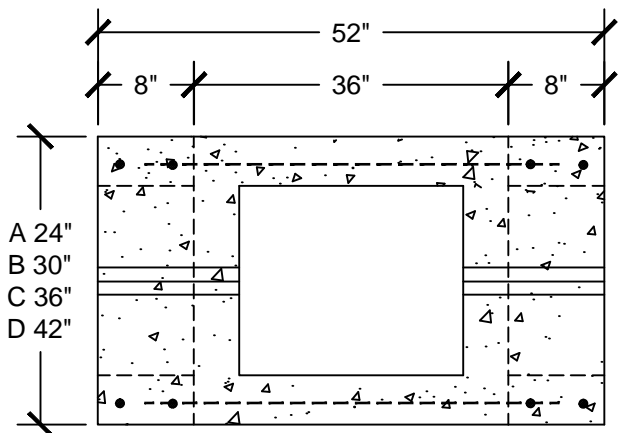
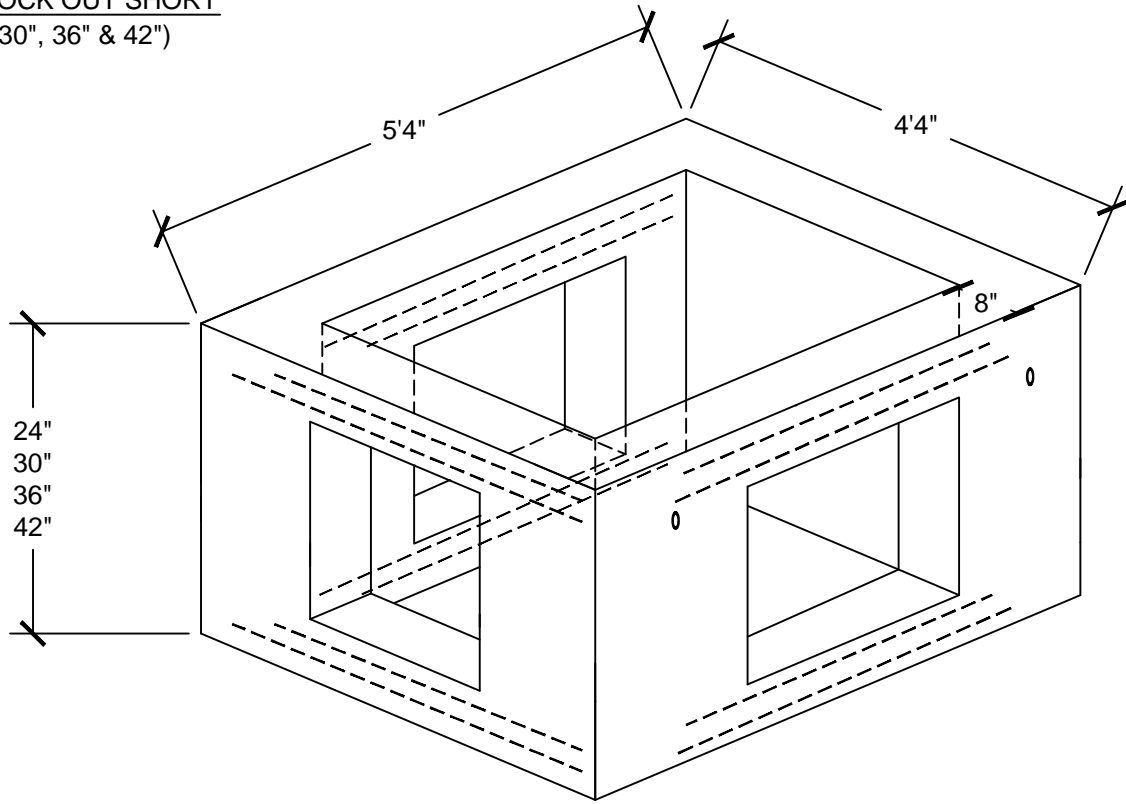

SECTION A-A

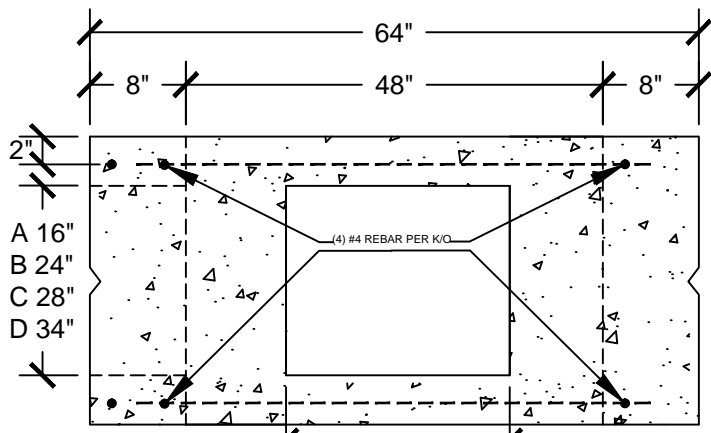

SECTION B-B

NOTE:

- A = 24" RISER WITH 16"x 24" KNOCK OUTS
- B = 30" RISER WITH 24"x 28" KNOCK OUTS
- C = 36" RISER WITH 28"x 28" KNOCK OUTS
- D = 24" RISER WITH 34"x 34" KNOCK OUTS

**CLASS "FSC" SELF-CONSOLIDATING CONCRETE
4,000 PSI**



**CROMWELL
CONCRETE
PRODUCTS INC.**
667 Main Street Cromwell CT 06416
(P) 860.633.5146 (F) 860.633.7469

PROJECT

TITLE
RISER W/ 2 KO LONG 1 SHORT

DESIGN	BGR	01/06/16	FILE No.
CADD	MF	01/06/16	SCALE AS SHOWN
REVIEW	MW	01/06/16	REV. 0
PROJECT No.			

DWG: RISER 2 KO LONG 1 SHORT